

VT 4.25

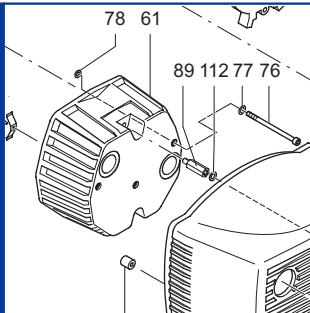

SERVICE

BECKER
D-42279 Wuppertal
www.becker-international.com

No. **C** year XXXX

type **VT 4.25-XX** Index Variante

frequency XXXX Hz
speed XXXX min⁻¹
power required XXXX kW
inlet capacity XXXX m³/h
pressure + XXXX mbar
vacuum - XXXX mbar

Made in Germany



Ersatzteilliste
Spare parts list
Liste de pièces de rechange
Listino pezzi di ricambio
Lista de piezas de recambio
Lista de peças sobresselentes
Reserveonderdelenlijst
Atsarginių dalių sąrašas
Varuosad nimekirja
Rezerves daļu saraksts

Reservedelsliste
Reservdelslista
Varaosuettelo
Reservedelsliste
Wykaz części zamiennych
Tartalékalkatrész lista
Seznam náhradních dílů
Seznam nadomestnih delov
Zoznam náhradných dielov
Rezervni dijelovi popis

Lista pieselor de schimb
Páirteanna spártha liosta
Κατάλογος ανταλλακτικών
Yedek parça listesi
Списък на резервните части
Перечень запасных частей
スペアパーツリスト
예비 부품 목록
备用零件目录



www.becker-international.com

Sales and service network

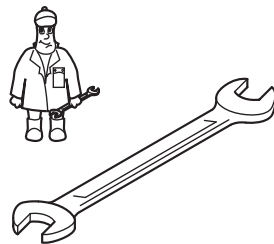

Wartung
Maintenance
Entretien
Manutenzione
Mantenimiento



Pos.	Menge ²⁾ Quantity Quantité Quantità Cantidad	Bestell-Nr. Ident No. No. Identification No. Identificazione No. de pedido	Bezeichnung Description Designation Designazione Descripción
24	SATZ/KIT	901349 00007	Schieber, Rotor Vane, Palette, Empujador
72	1	909505 00000	Filterpatrone, Filter cartridge, Cartouche Filtrante, Cartuccia filtro, Cartucho de filtro

²⁾ erforderliche Bestellmenge / necessary order quantity / quantité nécessaire / quantità di ordinazione necessari / cantidad necesario

VT 4.25

Standard



Variante



VT 4.25/XX

①

- 1~ Einphasenwechselstrom
- 1~ single-phase AC
- 1~ AC monophasé
- 1~ AC monofase
- 1~ AC monofásica

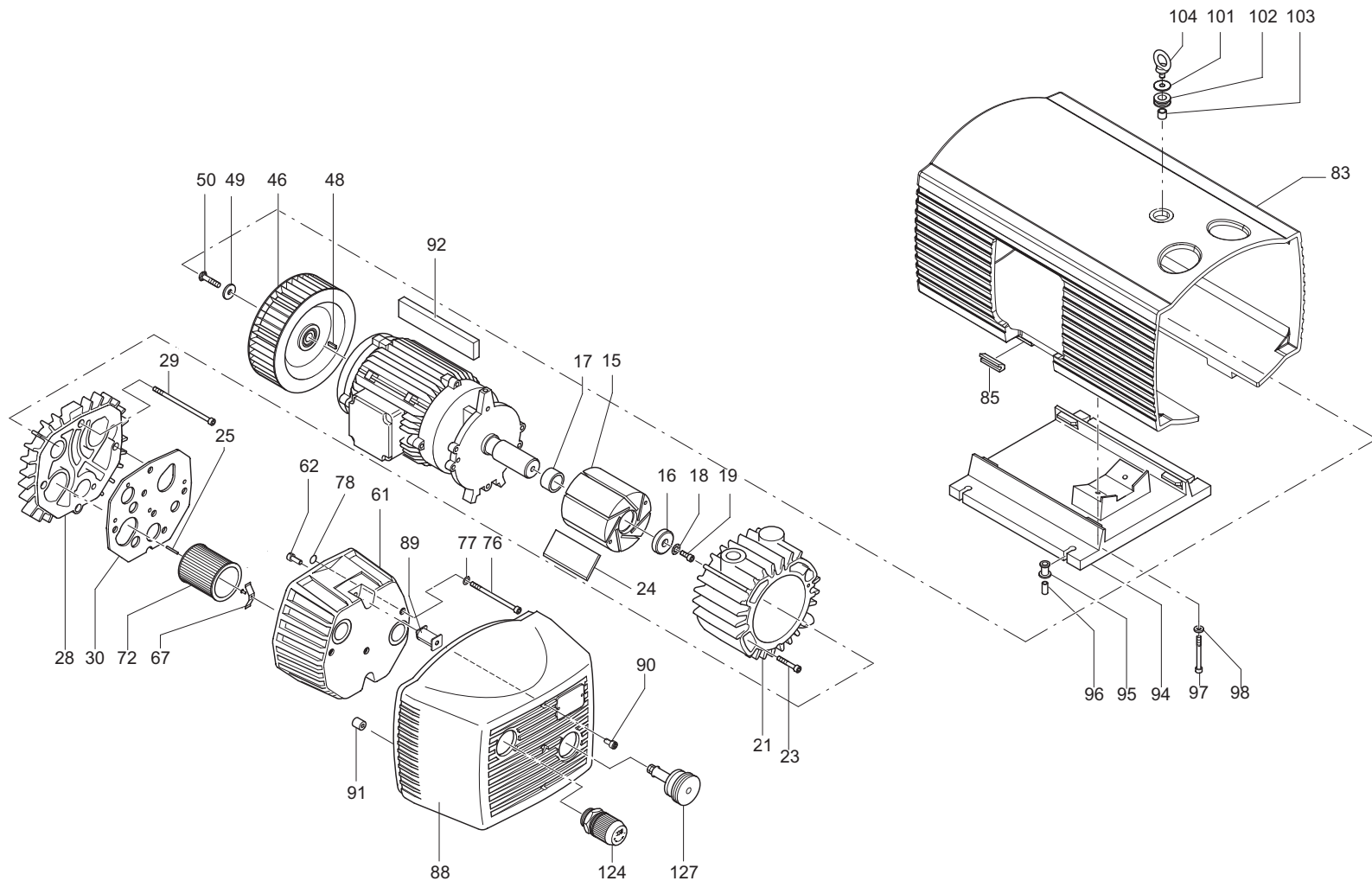

SERVICE

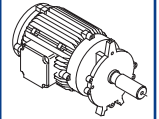

 C = ? μ F
 U = ? V

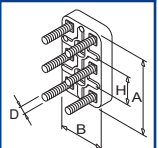
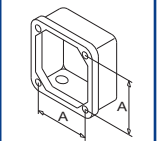
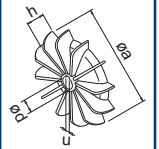
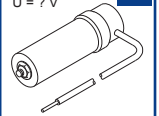
1~



C INDEX	Pos.	Bestell Nr.	Beschreibung	
VT 4.25	15	020000 16400	KOLBEN	
	16	016800 16500	SPANNSCHEIBE	
	17	911012 00000	STAR-TOLERANZRING	
	18	949203 00000	ZAHNSCHEIBE	
	19	945320 00000	INNENSECHSKANTSCHRAUBE	
	21	000101 16400	GEHÄUSE	
	23	945320 00000	INNENSECHSKANTSCHRAUBE	
	24	901349 00007	SCHIEBER, KOHLE (SATZ)	
	25	952009 00000	SPANNHÜLSE	
	28	000710 16500	SEITENDECKEL	
	29	945373 00000	INNENSECHSKANTSCHRAUBE	
	30	008900 16500	DICHTUNG	
	46	502301 16400	VENTILATOR MIT NABE	
	48	947713 00000	PASSFEDER	
	49	949454 00000	U-SCHEIBE	
	50	901804 00000	WELLENENDSCHRAUBE TUFLOK	
	61	004804 27600	FILTERDECKEL	
	62	945319 00000	INNENSECHSKANTSCHRAUBE	
	67	009000 16300	ANPRESSFEDER	
	72	909505 00000	FILTERPATRONE (1x)¹⁾	
	76	945373 00000	INNENSECHSKANTSCHRAUBE	
	77	948021 00000	DICHTRING	
	78	913161 00000	O-RING	
	83	006805 27500	GERÄTEHAUBE	
	85	951920 00000	GUMMIFORMTEIL	
	88	006802 27600	GERÄTEHAUBE	
	89	741300 27601	DÄMMAUFLAGE	
90	945318 00000	INNENSECHSKANTSCHRAUBE		
91	951922 00000	GUMMIFORMTEIL		
92	964110 00000	KANTENSCHUTZ		
94	015100 27600	FUSS		
95	951921 00000	GUMMIFORMTEIL		
96	068000 27600	DISTANZSTÜCK		
97	945328 00000	INNENSECHSKANTSCHRAUBE		
98	949451 00000	UNTERLEGSCHNEIBE		
101	833903 99597	VENTILTELLER		
102	951906 00000	KABELTÜLLE		
103	068002 16500	DISTANZROHR		
104	548800 16300	RINGSCHRAUBE		
124	736001 99613	VAKUUMREGULIERVENTIL		
127	727502 06000	ABBLASEVENTIL		

¹⁾erforderliche Bestellmenge / Wartung

C INDEX	Pos.	Ident No.	Description	
VT 4.25	15	020000 16400	ROTOR	
	16	016800 16500	CLAMPING DISC	
	17	911012 00000	STAR-TOLERANCE-RING	
	18	949203 00000	TOOTHED SPRING WASHER	
	19	945320 00000	SOCKET HEAD SCREW	
	21	000101 16400	PUMP BODY	
	23	945320 00000	SOCKET HEAD SCREW	
	24	901349 00007	CARBON VANES (KIT)	
	25	952009 00000	LOCATING PIN	
	28	000710 16500	LID	
	29	945373 00000	SOCKET HEAD SCREW	
	30	008900 16500	GASKET	
	46	502301 16400	FAN	
	48	947713 00000	KEY	
	49	949454 00000	WASHER	
	50	901804 00000	SHAFT END BOLT	
	61	004804 27600	FILTER COVER	
	62	945319 00000	SOCKET HEAD SCREW	
	67	009000 16300	BLADE SPRING	
	72	909505 00000	FILTER CARTRIDGE (1x)¹⁾	
	76	945373 00000	SOCKET HEAD SCREW	
	77	948021 00000	SEALING RING	
	78	913161 00000	O-RING	
	83	006805 27500	PROTECTING HOOD	
	85	951920 00000	RUBBER ELEMENT	
	88	006802 27600	PROTECTING HOOD (FRONT)	
	89	741300 27601	VIBRATION DAMPER	
90	945318 00000	SOCKET HEAD SCREW		
91	951922 00000	RUBBER ELEMENT		
92	964110 00000	EDGE PROTECTION		
94	015100 27600	FOOT		
95	951921 00000	RUBBER ELEMENT		
96	068000 27600	SPACING COLLAR		
97	945328 00000	SOCKET HEAD SCREW		
98	949451 00000	WASHER		
101	833903 99597	DISC		
102	951906 00000	RUBBER BUSHING		
103	068002 16500	SPACER TUBE		
104	548800 16300	EYE SCREW		
124	736001 99613	VACUUM REGULATING VALVE		
127	727502 06000	BLOW-OFF VALVE		

¹⁾ necessary order quantity / maintenance

C INDICE	Pos.	No. Identification	Designation		
VT 4.25	15	020000 16400	PISTON		
	16	016800 16500	DISQUE DE SERRAGE		
	17	911012 00000	BAGUE STAR		
	18	949203 00000	DENT DISQUE		
	19	945320 00000	VIS HEXAGONALE INTERNE		
	21	000101 16400	CORP DE POMPE		
	23	945320 00000	VIS HEXAGONALE INTERNE		
	24	901349 00007	PALETTE DE CHARBON (KIT)		
	25	952009 00000	DOVILLE DE ETRAGE		
	28	000710 16500	COUVERCLE		
	29	945373 00000	VIS HEXAGONALE INTERNE		
	30	008900 16500	JOINT		
	46	502301 16400	VENTILATEUR		
	48	947713 00000	CLAVETTE		
	49	949454 00000	RONDELLE		
	50	901804 00000	VIS BOUT D'ARBRE		
	61	004804 27600	COUVERCLE DU FILTRE		
	62	945319 00000	VIS HEXAGONALE INTERNE		
	67	009000 16300	RESSORT-JAME		
	72	909505 00000	CARTOUCHE FILTRANTE (1x)¹⁾		
	76	945373 00000	VIS HEXAGONALE INTERNE		
	77	948021 00000	JOINT		
	78	913161 00000	ANNEAU-O		
	83	006805 27500	CARTER PROTECTEUR		
	85	951920 00000	ELEMENT EN CAOUTCHOUC		
	88	006802 27600	CARTER PROTECTEUR		
	89	741300 27601	AMORTISSEUR DE VIBRATIONS		
90	945318 00000	VIS HEXAGONALE INTERNE			
91	951922 00000	ELEMENT EN CAOUTCHOUC			
92	964110 00000	PROTECTION D'ARETE			
94	015100 27600	PIED			
95	951921 00000	ELEMENT EN CAOUTCHOUC			
96	068000 27600	DONILLE D'ECARMENT			
97	945328 00000	VIS HEXAGONALE INTERNE			
98	949451 00000	RONDELLE			
101	833903 99597	PLATEAU DE SOUPAPE			
102	951906 00000	PROTECTION EN CAOUTCHOUC			
103	068002 16500	TUBE D'ECARTEMENT			
104	548800 16300	PITON			
124	736001 99613	SOUPAPE REGLAGE VIDE			
127	727502 06000	SILENCIEUX			







¹⁾ quantité nécessaire / entretien

C INDICE	Pos.	No. Identificazione	Designazione		
VT 4.25	15	020000 16400	ROTORE		
	16	016800 16500	DISCO DI FISSAGGIO		
	17	911012 00000	STAR-ANELLO TOLLERANZA		
	18	949203 00000	DISCO A DENTE		
	19	945320 00000	VITE ESAGONALE INTERNA		
	21	000101 16400	CARCASSA		
	23	945320 00000	VITE ESAGONALE INTERNA		
	24	901349 00007	PALETTE DI CHARBONE (KIT)		
	25	952009 00000	SPINE DI RISCONTRO		
	28	000710 16500	COPERCHIO		
	29	945373 00000	VITE ESAGONALE INTERNA		
	30	008900 16500	GUARNIZIONE		
	46	502301 16400	VENTILATORE		
	48	947713 00000	CHIAVETTA		
	49	949454 00000	RONDELLA		
	50	901804 00000	VITE DI CHIUSURA ALBERO		
	61	004804 27600	COPERCHIO FILTRO		
	62	945319 00000	VITE ESAGONALE INTERNA		
	67	009000 16300	MOLLA		
	72	909505 00000	CARTUCCIA FILTRO (1x)¹⁾		
	76	945373 00000	VITE ESAGONALE INTERNA		
	77	948021 00000	ANELLO GUARNIZIONE		
	78	913161 00000	ANELLO-O		
	83	006805 27500	CAPOTO DI PRTEZIONE		
	85	951920 00000	ELEMENTO IN GOMMA		
	88	006802 27600	CARTER DI PROTEZIONE		
	89	741300 27601	AMMORTIZZATORE DI VIBRAZIONI		
90	945318 00000	VITE ESAGONALE INTERNA			
91	951922 00000	ELEMENTO IN GOMMA			
92	964110 00000	LISTELLO DI PROTEZIONE			
94	015100 27600	PIEDE			
95	951921 00000	ELEMENTO IN GOMMA			
96	068000 27600	BOCCOLA DISTANZIATRICE			
97	945328 00000	VITE ESAGONALE INTERNA			
98	949451 00000	RONDELLA			
101	833903 99597	PIATELLO DELLA VALVOLA			
102	951906 00000	PROTEZIONE IN GOMMA			
103	068002 16500	TUBO DISTANZA			
104	548800 16300	GANCIO			
124	736001 99613	VALVOLA REGOLAZIONE VUOTO			
127	727502 06000	SILENZIATORE			

¹⁾ quantità di ordinazione necessari / manutenzione

C INDICE	Pos.	No. De pedido	Descripción		
VT 4.25	15	020000 16400	ÉMBOLO		
	16	016800 16500	ARANDELA TENSORA		
	17	911012 00000	ANILLO DE TOLERANCIA STAR		
	18	949203 00000	POLEA DENTADA		
	19	945320 00000	TORNILLO HEXAGONAL INTERIOR		
	21	000101 16400	CARCASA		
	23	945320 00000	TORNILLO HEXAGONAL INTERIOR		
	24	901349 00007	EMPUJADOR DE CARBÓN (KIT)		
	25	952009 00000	CASQUILLO TENSOR		
	28	000710 16500	TAPA LATERAL		
	29	945373 00000	TORNILLO HEXAGONAL INTERIOR		
	30	008900 16500	JUNTA		
	46	502301 16400	VENTILADOR CON CUBO		
	48	947713 00000	LENGÜETA DE AJUSTE		
	49	949454 00000	ARANDELA		
	50	901804 00000	TORNILLO TERMINAL DE ÁRBOL TUFLOK		
	61	004804 27600	TAPA DE FILTRO		
	62	945319 00000	TORNILLO HEXAGONAL INTERIOR		
	67	009000 16300	MUELLE DE PRESIÓN		
	72	909505 00000	CARTUCHO DE FILTRO (1x)¹⁾		
	76	945373 00000	TORNILLO HEXAGONAL INTERIOR		
	77	948021 00000	ANILLO DE JUNTA		
	78	913161 00000	JUNTA TÓRICA		
	83	006805 27500	CAPERUZA DE APARATO		
	85	951920 00000	PIEZA DE ORMA DE GOMA		
	88	006802 27600	CAPERUZA DE APARATO		
	89	741300 27601	AMORTIGUADOR DE VIBRACIONES		
90	945318 00000	TORNILLO HEXAGONAL INTERIOR			
91	951922 00000	PIEZA DE ORMA DE GOMA			
92	964110 00000	PROTECCIÓN DE CANTOS			
94	015100 27600	PIE			
95	951921 00000	PIEZA DE ORMA DE GOMA			
96	068000 27600	PIEZA DISTANCIADORA			
97	945328 00000	TORNILLO HEXAGONAL INTERIOR			
98	949451 00000	ARANDELA			
101	833903 99597	PLATILLO DE VÁLVULA			
102	951906 00000	BOQUILLA DE CABLE			
103	068002 16500	TUBO DISTANCIADOR			
104	548800 16300	TORNILLO DE CÁNCAMO			
124	736001 99613	VÁLVULA REGULADORA DE VACÍO			
127	727502 06000	VÁLVULA DE BARRIDO			

¹⁾ cantidad necesario / mantenimiento

VT 4.25	Variante 	Pos. ²⁾	Bestell Nr. / Ident No. / No. Identification / No. Identificazione / No. De pedido		Beschreibung / Description / Designation / Designazione / Desripcion
			  	  	
① 1~ Einphasenwechselstrom 1~ single-phase AC 1~ AC monophasé 1~ AC monofase 1~ AC monofásica		13	742002 30000		KABEL / CABLE / CABLE / CAVO / CABLE
		83	906806 27500	006805-27500	HAUBE / PROTECTING HOOD / CARTER PROTECTEUR / CARTER DI PROTEZIONE / CAPERUZA
		94	515101 27600	045100-27600	FUSS / FOOT / PIED / PIEDE / PIE

²⁾ variantenabhängige Bauteile / variant-dependent components / composants variante-dependantes / componenti variante-dispendenti / componentes variante-dependientes